

Link do produktu: <https://kaldekor.pl/biurko-narvik-b1-czarny-dab-sonoma-p-9609.html>



## Biurko NARVIK B1 czarny / dąb sonoma - Halmar

Nasza cena brutto	<b>299,00 zł</b>
Dostępność	<b>Dostępny</b>
Czas wysyłki	<b>48 godzin</b>
Numer katalogowy	<b>5905248115323</b>
Kod producenta	<b>V-CH-NARVIK-B1-CZARNY/SONOMA</b>
Kod EAN	<b>5905248115323</b>

### Opis produktu

## Biurko NARVIK B1 czarny / dąb sonoma - Halmar

wymiary: 120/64/120 cm, materiał: płyta meblowa laminowana / stal malowana proszkowo, kolor: czarny - dąb sonoma, możliwość montażu regału po lewej lub prawej stronie

Rodzaj:	biurko
Styl wykonania:	skandynawski, loft, nowoczesny
Materiał:	płyta meblowa laminowana
Szerokość (Zakres):	120
Nazwa kolekcji:	Narvik
Wysokość:	120
Głębokość:	64
Kolor:	czarny, dąb sonoma
Waga brutto:	17.500
Waga netto:	17.000
Objętość:	0.061
Jednostka miary:	szt.
Ilość w paczce:	1
Ilość paczek:	1
Paczka 1:	131.00 x 67.00 x 7.00, 17.50 KG





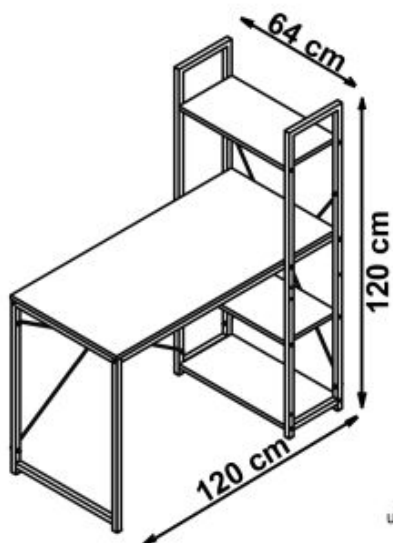





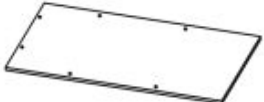

Instrukcja montażu biurka Narvik B1

Instrukcja montażu biurka Narvik B1



# NARVIK B-1

HALMAR Sp. z o.o.  
 ul. Centralnego Okręgu Przemysłowego 2, 37-450 Stalowa Wola, POLSKA / POLAND  
 tel. +48 15 843 28 10, fax: +48 15 842 19 57, e-mail: office@halmar.com.pl

<p>A</p>  <p>2pcs</p>	<p>B</p>  <p>3pcs</p>	<p>C</p>  <p>1pc</p>
<p>D</p>  <p>2pcs</p>	<p>E</p>  <p>1pc</p>	<p>F</p>  <p>2pcs</p>
<p>G</p>  <p>8pcs</p>	<p>H</p>  <p>6. 3x40 12pcs</p>	<p>I</p>  <p>M6x45 4pcs</p>
<p>J</p>  <p>M6x30 8pcs</p>	<p>K</p>  <p>M6x27 8pcs</p>	<p>L</p>  <p>M6 12pcs</p>
<p>M</p> 	<p>N</p> 